

Douglas Instruments Ltd

Oryx4

Hardware Manual

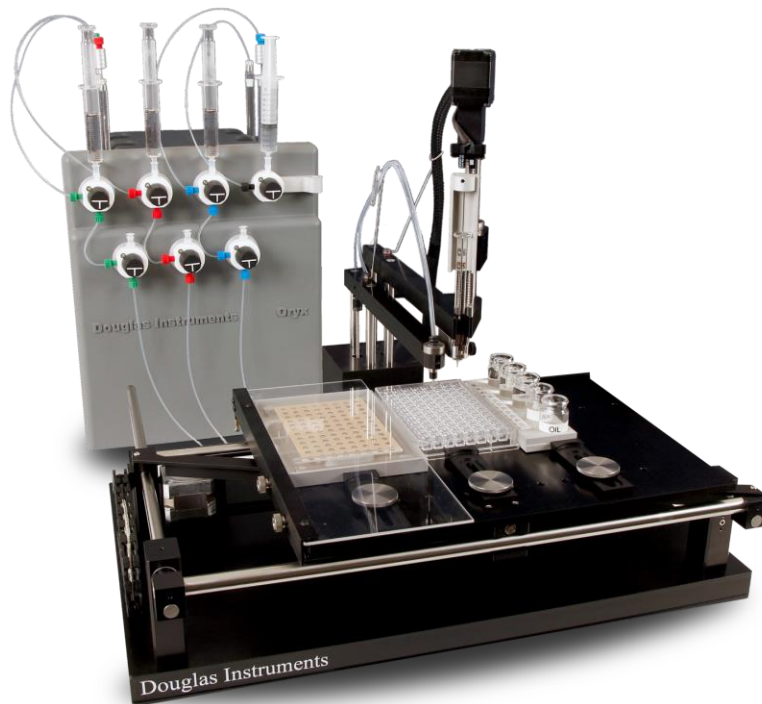

Description and Configuration

Revision 8.05 July 2024

Compiled by Patrick Shaw Stewart, Peter Baldock and Stefan Kolek

Copyright 1991-2024, Douglas Instruments Ltd.

Douglas Instruments Limited

Douglas House ♦ East Garston ♦ Hungerford ♦ Berkshire, RG17 7HD ♦ UK

<https://www.douglas.co.uk>

Warnings



Always turn off the MCC and disconnect the power cord from the mains supply before disassembling any parts of the machine or unplugging the leads for the Chassis or Plateloader

For **indoor use only** within the temperature range of 4-30°C 0-75%RH (Non-condensing)



Oryx Protein Crystallization machines are designed for use with **non-hazardous materials only**. Should the user choose to process hazardous materials it would be the user's responsibility to observe any special handling procedures.

Front Panel - Using C:\Program I



The **Red stop button** in the FrontPanel software will terminate any movement of the plateloader, arms and syringes, the purpose being to avoid spillage or other loss of oil, protein or reagents. The machine complies with all Essential Health and Safety Requirements of the EU Machinery Directive for CE Marking

Specifications

Power: 100-240 Vac Universal Input; 5A: 50Hz ~ 60 Hz

Continuous sound pressure level in normal operation at the operator's workstation: below 70dB(A) – ear protection need not be worn.

Manufactured by: Douglas Instruments Ltd.
Douglas House, RG17 7HD, UK
<http://www.douglas.co.uk>

Type: ORYX CRYSTALLIZATION MACHINE



CONTENTS

SETTING UP THE SYSTEM	6
Layout of the Hardware.....	6
Unpacking equipment.....	6
System Overview Diagram.....	7
Assembly and Preparation.....	8
Electrical Connection.....	8
Installing the Z and V Arms.....	8
Software Installation.....	8
Rezero of Motors.....	9
Initial Calibration and Testing.....	9
Rezeroing Motorized Syringe Drivers.....	10
Mounting 100 µl Gas-Tight Syringes on Motorized Syringe Drivers, and Filling them with Water.....	10
Installing 2.5 ml syringe.....	11
Testing the Performance of the Plateloader.....	12
Realigning the Plateloader.....	12
Align Evaporation Shield.....	13
Rezeroing all Motors of the Plate Loader.....	13
FRONT PANEL MENU ITEMS	14
File Menu.....	14
Reset Application Link.....	14
Open WaspRun.....	14
Open XStep.....	14
Collect Diagnostic data.....	14
Display MCC Terminal.....	14
Exit	14
Actions Menu.....	14
Debubble.....	15
Calibrate Plate.....	15
Install or Adjust Tip.....	15
Recover Protein and Precious Solutions.....	15
Release LCP Syringe (LCP Dispensing Only).....	15
Flush Dispensing Tip.....	15
Rezero 15	15
MCC Menu.....	15
MCC Diagnostics.....	15
Rezero All Motors.....	15
Power Down all motors.....	16
Set PowerDown Delay.....	16
Plateloader Menu.....	16
Install Tip.....	16
Clear Tip Offsets.....	16
Test and Adjust Tip Position.....	16
Calibrate Plate.....	16
Rezero 16	16
Set Inaccuracy tolerance.....	17
Home	17

Set Home Time Out.....	17
Insert and eject Arms.....	17
Goto (X, Y, Z)	17
Test Axis.....	17
Align Table and Arm	17
Start Installation.....	17
Solutions Menu	17
Debubble	17
Clean and Empty Dispensing Tip	17
Edit Bore Values.....	18
Set Available Volume	18
Protein and Precious materials.....	18
Oil 18	
Rezero Syringe Drives.....	18
Configuration Menu.....	18
Small Volume Dispensing on Z Arm.....	18
Large Volume Dispensing on V Arm	18
LCP Dispensing on LCP Arm	18
Large Volume Dispensing on LCP Arm.....	18
Options Menu.....	19
Attach Shield In Hook Position	19
Sound Alerts.....	19
Allow Front Panel to Steal Focus	19
Execute in Background.....	19
Use Fast Large Volume Handling.....	19
Advanced Menu Items.....	19
Administrator Mode	19
Help Menu.....	20
Open Hardware Manual	20
About Front Panel.....	20
Software Version Record.....	20
Disk Version Record.....	20
USE AND MAINTENANCE OF THE HARDWARE	21
Installing Microtips.....	21
Refilling 100µl Gas-Tight Syringes with Water	21
Debubbling	21
Flushing Tubing between Valves.....	22
Filling Microtip with Solution	22
Dispensing Experiments.....	22
Attaching the Evaporation shield for Vapor Diffusion Experiments.....	23
Flushing Microtip after Use	24
Always wear protective goggles when handling caustic materials	24
Protein Coatings of Microtip	24
Blockages	24
Unblocking Microtips	24
Chemical Inertness	24
Tubing Connections.....	24
Lubrication of Syringe Drivers and Plate Loader.....	27
Lubrication of Shafts.....	27
Lead-screws	27
Ball screws - used on syringe drives (USDs)	27
Spillages.....	27
XYZV Plate Loader	27

Adjustment of XYZV Plate Loader.....	27
HARDWARE CONFIGURATION AND CONTROL	28
Using Different Syringes with the System.....	28
Changing Plates.....	28
WASP and WASPRUN.....	28
XSTEP – Changing Plates.....	28
Hardware Configuration Files.....	29
HARDWARE.FTH.....	29
Specifications.....	29
Creating or editing plate definitions.....	30
MCC BIOS SETTINGS	31
HEALTH AND SAFETY ANALYSIS	33
Electrical Safety.....	33
Mechanical Safety.....	33
Chemical Safety.....	33
Emergency Stop.....	33
Safety Features.....	33
Risk Analysis.....	34
1. Electrical.....	34
2. Mechanical.....	34
EU DECLARATION OF CONFORMITY	35
Electromagnetic compatibility of multimedia equipment Immunity requirements.....	35
UK DECLARATION OF CONFORMITY	36
Electromagnetic compatibility of multimedia equipment Immunity requirements.....	36
EXPERIMENT CARDS FOR ORYX	37
Oryx Quick Start Card.....	37
ORYX MAINTENANCE CARD	38
Daily maintenance	38
Weekly maintenance	38
Yearly maintenance	38
Optimization Experiment Card.....	39
Good dispensing guide for the Oryx range of robots.....	42
INDEX OF MANUAL	43

SETTING UP THE SYSTEM

Layout of the Hardware

A typical setup of an Oryx4 or Oryx8 system is shown below. The system is controlled by a PC which is connected to the MCC (Motion Control Center). The MCC is then connected to the XYZV Plateloader and Chassis via the PoE Switch (Power over Ethernet). The PoE switch distributes power to the stepper motors in the XYZV Plateloader and motorized syringes in the Chassis.

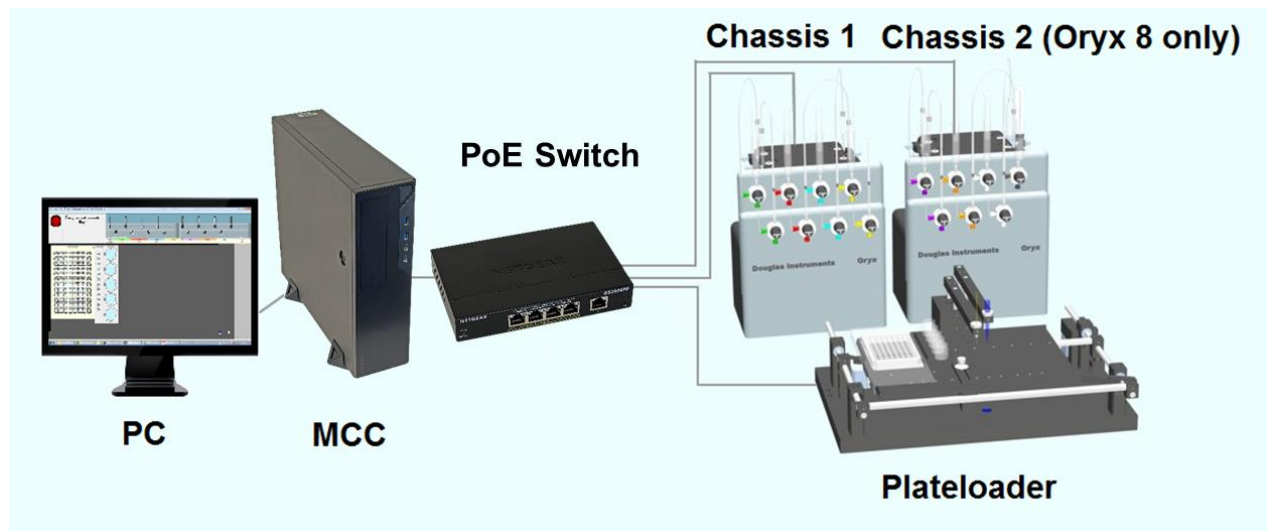

Oryx Hardware layout

Unpacking equipment

Take care when unpacking the system. Start by unpacking the Chassis, MCC Motion Control Center, and XYZV Plateloader. Then locate the Z- and V-arms, MCC connection cables, tool box and syringes. Remove consumables such as plates, Microtips and screens and place onto shelves or into draws.

System Overview Diagram

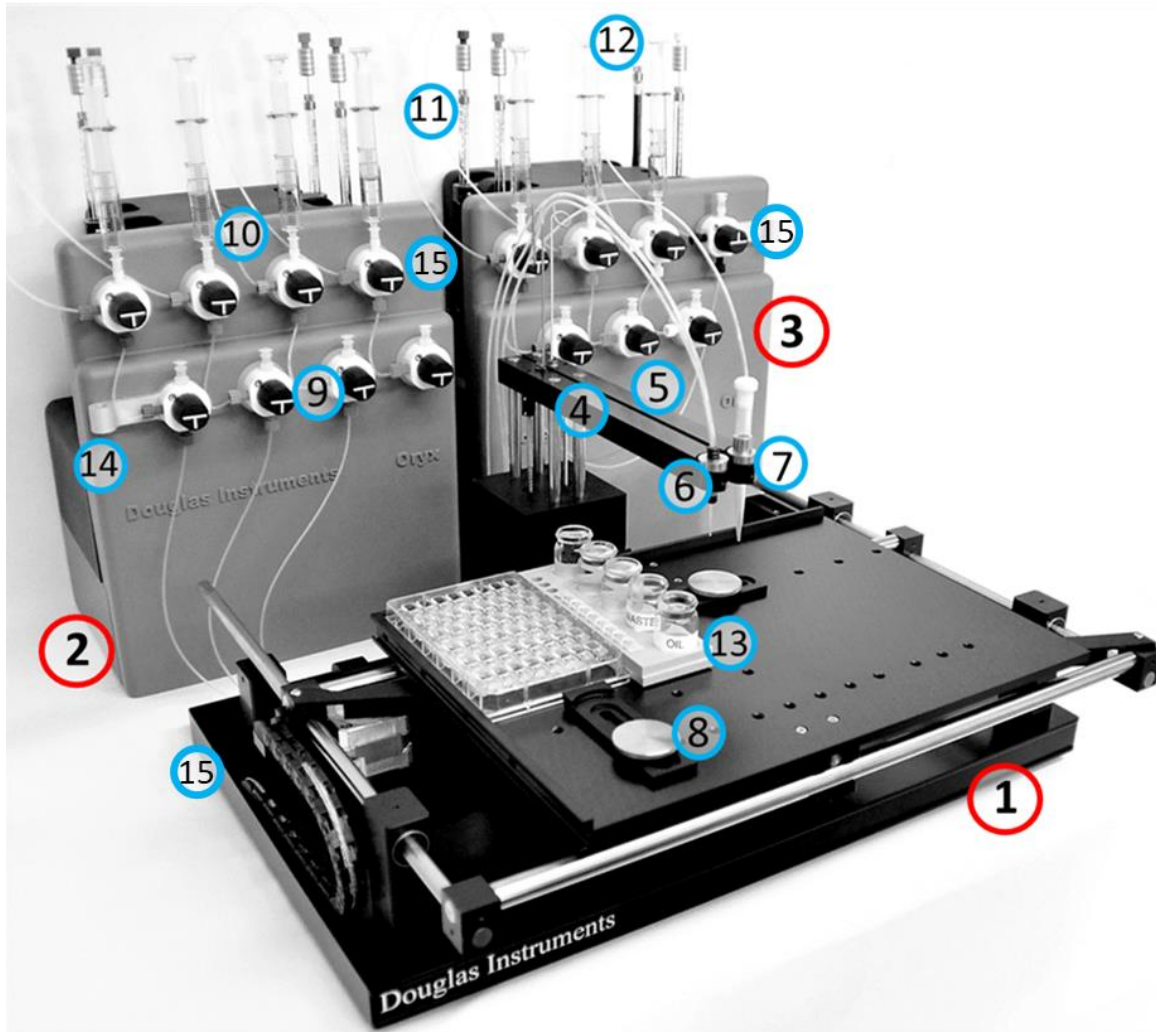

- | | |
|--------------------------------------------|----------------------------------|
| 1. XYZV Plateloader | 9. PTFE 3 port valve |
| 2. Chassis 1 | 10. 5 mL Glass syringe |
| 3. Chassis 2 | 11. Hamilton 100 μ L syringe |
| 4. Z Arm | 12. Hamilton 2.5 mL syringe |
| 5. V Arm | 13. Protein Load Rinse Block |
| 6. Microtip attached to Z Arm using Collet | 14. Tip Holder |
| 7. 1 mL Rainin RT-1000 disposable tip | 15. LED Status light |
| 8. Table Clamp | |

Assembly and Preparation

1. Prepare an appropriate area of lab bench for the system.
2. Wipe Plateloader to remove dust. Remove all packaging and protection from system transit.
3. Replace temporary plastic x-axis front fork with permanent X-axis fork with bearing (located in tool box.)
4. Check Plateloader moves freely over entire range of movement in X and Y-axis.
5. Remove dust protection caps from syringe luers. Check all luers and fittings are fastened tightly.
6. Install syringes into Universal Syringe Drives (USDs) in chassis. Follow instructions on page 7.

Electrical Connection

1. All cables are individually labeled where applicable. Use the USB NMC (null modem cable) cable to connect the PC to a USB port of the MCC.
2. Using the provided Ethernet cables, connect the PoE Switch to the MCC (from input port 5). Also connect the PoE Switch to the Chassis and Plate Loader (from ports 1-4 of the PoE Switch).
3. Turn on MCC and power on the PoE switch using the power switch provided. Check the LED status lights on the Plateloader and Chassis are steady blue.

The MCC also possesses outputs for a screen (VGA, HDMI), keyboard and mouse (USB). These can be used to diagnose malfunctions.

Installing the Z and V Arms

Now install the Z-arm as follows:

1. Unwrap the Z-arm.
2. Lower the Z-arm into position and allow the lead screw to settle on the center of the motor inside the ZV-box. The arm will automatically be pulled in to the correct position on the first rezero of the table.
3. Repeat steps 1 – 3 to install the V-arm.
4. Attach guide loops for Z and V arms. Ensure they are positioned so the Microtip follows a path parallel to the arm.

Software Installation

Once all the equipment is set up and connected to the MCC the Douglas Instruments Crystallization Software can be installed. Follow the instructions in the document on the CD called **Installation Instructions.rtf** to install the crystallization software.

Rezero of Motors

After Installing the software open the program called **Front Panel** by clicking on the desktop shortcut. When Front Panel opens its will automatically rezero the Plateloader and Syringe drive motors.

To rezero motors manually Open Front Panel and select **MCC > Rezero all Motors**

Initial Calibration and Testing

Once the system is setup and the software has been installed, please complete the following test and calibration procedures:

1. **Find Index Positions.** (Calculates the error/consistency of movement between the zero position of the motor and the optical limit switch.) In *Front Panel* Click **Plateloader > Start Installation > Find Index Positions**. Record 'Spread' values for X, Y, Z and V in table below. Values should not be higher than 0.050 mm.
2. **Test Axes** In *Front Panel* Click **Plateloader > Start Installation > Test Axes**. The machine will find the maximum operational speed of each axis. The maximum speed value should not be lower than 1.6. Record Test axes speed factor values for X, Y, Z and V below. For more details see page 10.
3. **1 Point alignment calibration.** (Calibrate the position of the Z arm with respect to the plate loader table.) In *Front Panel* Click **Plateloader > Start Installation > Simple 1 point alignment**. Insert calibration needle pointer into Z arm. Arm will align with table dowel. Move arm e.g. 2mm to one side of the dowel and lower the arm to align the arm height with the table surface. Move the arm back over the dowel and position so the needle is over the centre of the dowel. Record the X, Y and Z positions of the needle when centred over the dowel..
4. **Calibrate plate.** Insert calibration needle pointer in Z arm. In *Front Panel* Click **Plateloader > Calibrate plate**. The calibrate plate wizard aligns the needle pointer to the four corners of a plate and creates a calibration file with dx, dy and dz values for each position. This increases dispensing accuracy.
5. **Align Evaporation Shield.** Select Plateloader -> Start installation -> Align Evaporation Shield. Attach the evaporation shield when asked by Front Panel. The shield will now engage and move to the shield alignment test position. Use the left and right arrows to adjust the shield roller position so that is just misses the leading (front) edge of the roller channel. Test the shield is able to engage in the roller channel by sliding forward and backward. Click accept to save shield calibration position.

Find Index Positions (Spread)	X:	Y:	Z:	V:
Test Axes (Speed Factor)	X:	Y:	Z:	V:
1 Point alignment	X:	Y:	Z:	
Evaporation shield alignment	X:			
Plates Calibrated:				

Once these initial calibration tests have been performed it is recommended to run a test experiment with water or protein to check the liquid handling of the system before first time use.

1. Check all syringes are moving correctly.
2. Install Microtip.
3. Inspect liquid handling with water or test protein.
4. Begin experiments with protein. All drops should be consistent and accurate. **Contact Douglas Instruments if your drops aren't perfect!**

Rezeroing Motorized Syringe Drivers

1. Switch on the MCC. Wait for around 20s to allow it to fully boot up (All red and green lights should go out). Switch on the host PC, and allow it to boot up.
2. Open Front Panel by clicking on the desktop shortcut.
3. Click on **Actions > Rezero**.
4. Make sure that the check boxes are selected for all of the syringes, and click on continue.
5. Turn the top row of valves as indicated in Front Panel.
6. Click **Rezero**
7. Wait for the syringe drives to reach the lowest position.
8. Click finish to end the wizard.

Mounting 100 μ l Gas-Tight Syringes on Motorized Syringe Drivers, and Filling them with Water

1. Prepare about 250 ml of degassed pure water. This will prevent bubbles forming, and is essential for accurate dispensing.
2. Rezero syringe drives as described above.
3. Attach Hamilton Gas-Tight syringe and plunger to motorized syringe drive using syringe barrel adapter (Hex key tool necessary – in red tool box.) Tighten both screws.
4. Pull the **plunger** of the gas-tight syringe into the **syringe button clamp** and tighten the grub-screw to fix the plunger (Hex key tool and grub screw necessary – in red tool box.)

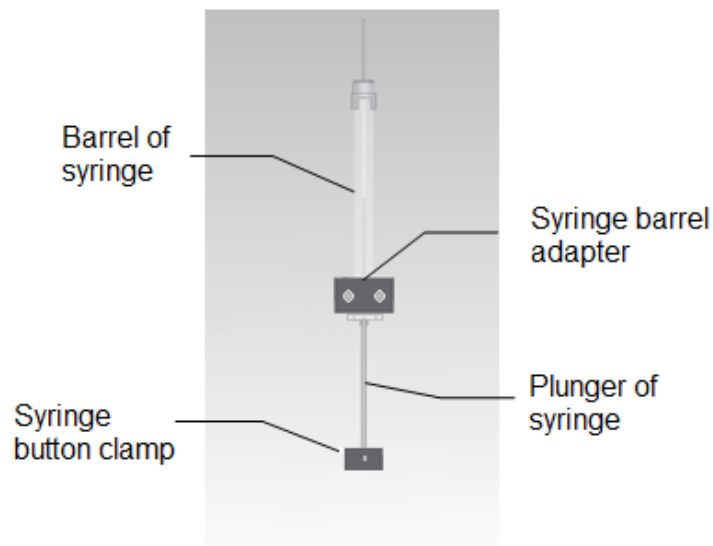

5. Connect the needle of the gas-tight syringe to the upper valve by pressing the connecting tubing onto it as far as the gripper fitting. **Do not push needle through gripper fitting.**
6. Fill a ground-glass syringe with degassed pure water and place it in the female Luer connection on the upper valve.

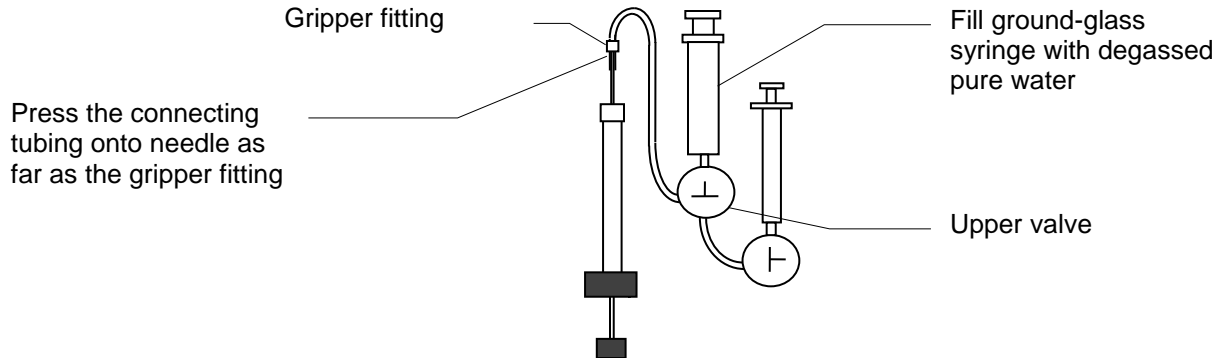

7. Undo the syringe barrel adapter from the syringe drive by untightening the two screws, and remove the barrel of the gas-tight syringe, leaving the plunger in position.
8. Place the barrel over a waste container, turn valves as shown in the diagram, and flush all air and bubbles out of the connecting tubing and gas-tight syringe.

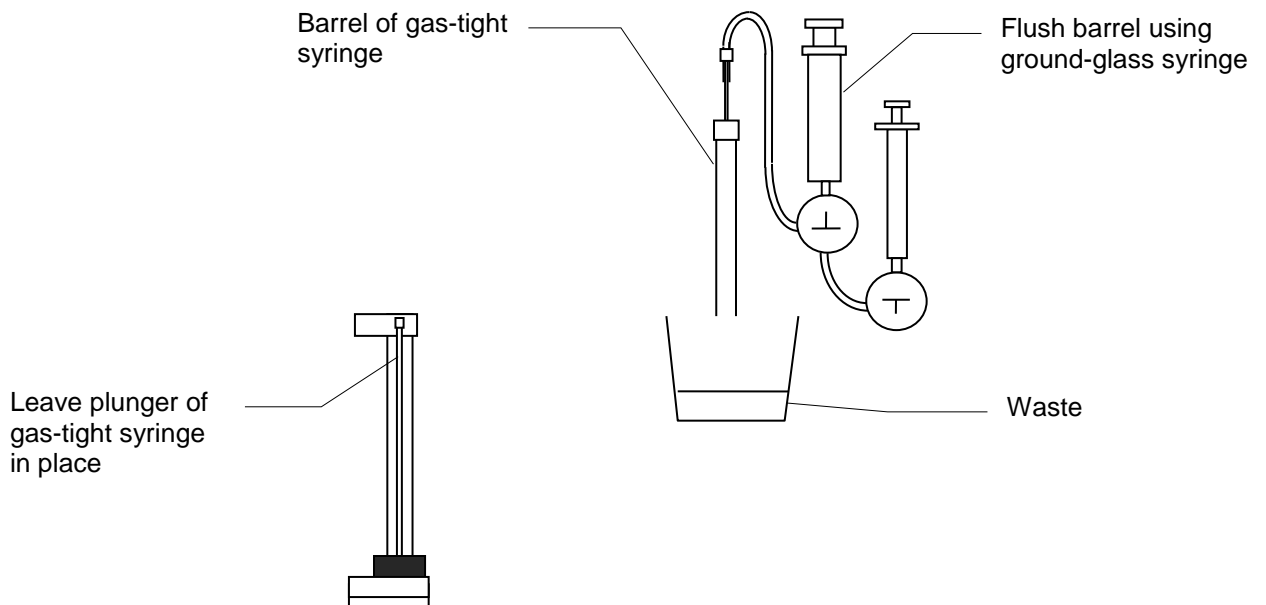

9. Repeat steps 1-8 for the remaining low volume channels.

Installing 2.5 ml syringe

Connect the 2.5 mL syringe to the number 8 syringe drive. The 2.5 mL syringe should contain only air and **the user must not fill it with water!**

Testing the Performance of the Plateloader

1. Start *Front Panel*
2. Click *Options | Advanced Menu Items* - to turn on Advanced Menu Items
3. Click *Options | Administrator Mode* – to turn on Administrator mode
4. Click *Plate Loader | Diagnostics | Test Axis*
5. Set *Axis* to X, *Speed factor* to 1.3, *Amplitude* (mm) to 10, *Oscillations* to 10, *Places to test* to 5, and *Starting at* to 0.0. Click *Test*.
6. If the Plate Loader misses steps, inform Douglas Instruments of the problem. Then reduce the *Speed factor* to 1.2 and repeat step 4 (again, try five times). If this fails, continue reducing the speed.
7. Follow a similar procedure for the Y, Z and V axes. If the Plate Loader misses steps, reduce the speed.
8. Click *Options | Administrator Mode* – to turn off Administrator mode
9. Click *Options | Advanced Menu Items* - to turn off Advanced Menu Items

Realigning the Plateloader

1. Select Plateloader -> Start installation -> Simple 1-Point Alignment.
2. Install the 'mounted needle' into the Z-arm (you should find this in the red plastic box)
3. The calibration needle will move over the sunken 'dowel' position.
4. Move the needle to one side of the dowel position e.g. 2mm to the left, so that the needle is over the table. Lower the needle and adjust so it is just touching the table.
5. Align the needle so it is centered above the dowel.
6. Click accept to specify the new calibration reference position. **NOTE: once the platel loader is re-aligned it will affect the roller evaporation shield alignment and other alignments. In this case please now re-align the roller evaporation shield and re-calibrate plates.**

Please note:

When you align the tip on the destination plate in an experiment these offsets are used on all other plates. If the tip is bent and the end of the tip is far away from the centre of the collet then it may appear to be off centre when it loads protein. If you look closely you should see that the end of the tip is in the centre of the protein tube when it starts to go down, but the collet may be so far off centre that it hits the side of the tube.

It is best to try to straighten the tip by hand or to adjust the tip in the guide loop to be pointing straight down and in the centre of the collet before starting an experiment.

Align Evaporation Shield

1. Select Plateloader -> Start installation -> Align Evaporation Shield.
2. Attach the evaporation shield when asked by Front Panel.
3. The shield will now engage and move to the shield alignment test position.
4. Use the left and right arrows to adjust the shield roller position so that it just misses the leading (front) edge of the roller channel. Test the shield is able to engage in the roller channel by sliding forward and backward.
5. Click accept to save shield calibration position.

Rezeroing all Motors of the Plate Loader

1. Switch on PC and MCC, and start the program *Front Panel* as described above.
2. *Actions | Rezero*. Follow instructions to rezero Syringe Drives, Z, V, X and Y motors.

FRONT PANEL MENU ITEMS

File Menu

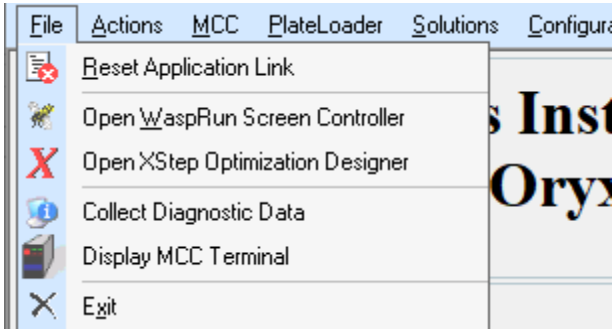

Reset Application Link

Used to re-establish a link with another application i.e. XStep.
Mostly used for debugging.

Open WaspRun

Open WaspRun.exe to design screening experiments or simple optimization experiments.

Open XStep

Open XStep.exe to design optimization experiments see experiment card at end of manual or online <http://www.douglas.co.uk/cards.htm>

Collect Diagnostic data

Collect important system information to send to Douglas Instruments for analysis.
We may ask you to send the diagnostic data to us if your machine is not functioning correctly.

Display MCC Terminal

Display MCC terminal to send low level commands to the MCC.

Exit

Exit Front Panel.

Actions Menu

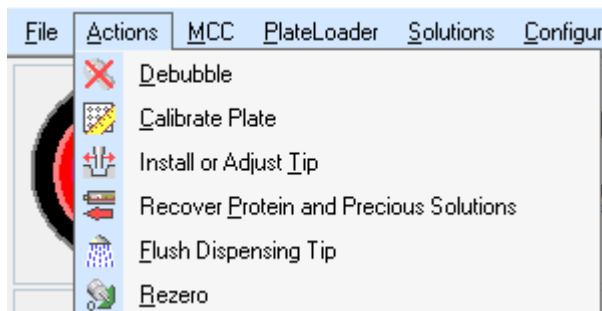

All of these items can also be found in other menus but are grouped here for convenience and for inexperienced users: If 'Advanced Menu Items' is turned off in 'Options' menu then only the 'Actions Menu' will be displayed.

Debubble

Run the Debubble wizard to remove air from the tubing above the top valves.

Calibrate Plate

Calibrate plate allows existing plate definitions to be tweaked to ensure perfect drop dispensing position accuracy. We recommend calibrating plates that you use regularly. Each plate type e.g. SwissCI_2drop should only need to be calibrated once ever. Please ensure you take care to calibrate the plate accurately and consistently:

- Use the mounted calibration needle in the red tool
- Adjust to centre of well
- Adjust so the needle is just touching the plate, you should see / feel the top of the calibration device raise slightly when touching the plate

Install or Adjust Tip

Runs the Install and Adjust tip wizard.

Recover Protein and Precious Solutions

Runs a wizard to recover protein to a plate or tube.

Release LCP Syringe (LCP Dispensing Only)

Release the LCP containing Hamilton syringe from the LCP drive.

Flush Dispensing Tip

Open the flush tip wizard to fill the microtip with water. This wizard will appear at the start of all experiments, except optimization reservoir dispensing experiments that do not require a microtip.

Rezero

Runs a wizard to rezero the syringes and / or table if they have been obstructed.

MCC Menu

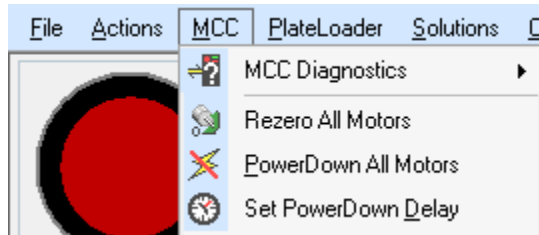

MCC Diagnostics

Test and collect diagnostic data from the MCC.

Rezero All Motors

Forces a rezero of all motors to recalibrate start positions – use in case syringes or Plateloader was obstructed during use.

Power Down all motors

Turns off power to all motors to allow manual positioning of the table or to stop the noise produced by the syringe drives. Table will automatically rezero before next move.

Set PowerDown Delay

Sets the delay before the power is automatically turned off when the table is in the Home position.

Plateloader Menu

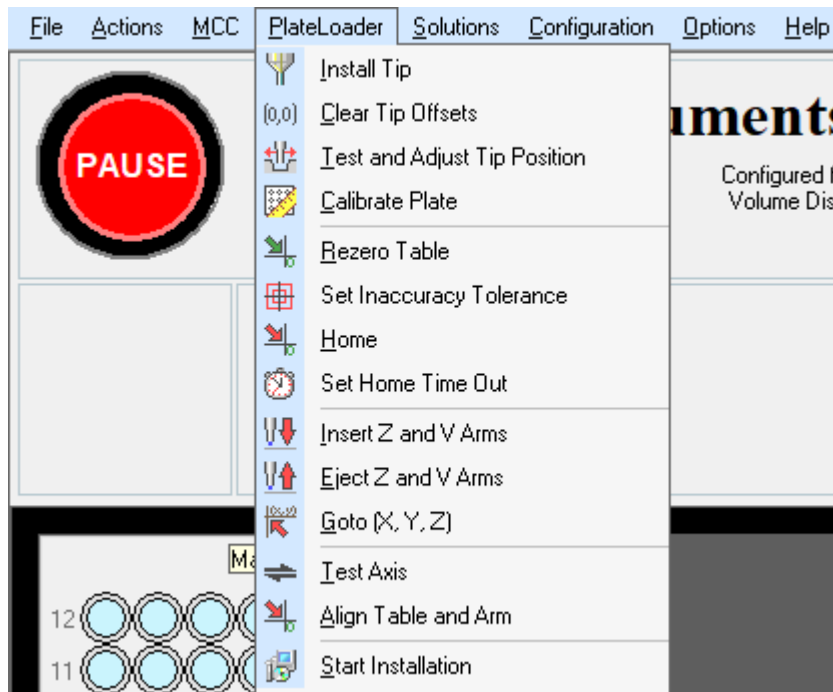

Install Tip

Starts a wizard to install a different tip including the initial height setting for a new tip

Clear Tip Offsets

Sets the X, Y and Z/V offsets used in 'Test and Adjust Tip Position' back to all Zeros.

Test and Adjust Tip Position

Starts a wizard to align the tip to a well on the target plate.

Calibrate Plate

See Calibrate Plate description under "Actions".

Rezero

Runs a wizard to rezero the XYZV table.

Set Inaccuracy tolerance

Specify threshold value for plateloader inaccuracy. If the value is exceeded a rezero error message. You will see a rezero error message e.g. if the plateloader crashes into a bottle. If you see the **rezero error message consistently please contact Douglas Instruments.**

Home

Moves the table to the Home position.

Set Home Time Out

Sets the delay before the table automatically goes to the Home position and the Powerdown Timer starts.

Insert and eject Arms

Procedure to remove arms. E.g. if the system is to be moved.

Goto (X, Y, Z)

Specify coordinates or click on a location for the robot to move to.

Test Axis

This procedure tests the systems movement for a particular axis. Only used for calibration and testing.

Align Table and Arm

Calibration procedure, see 1 Point Alignment (page 4).

Start Installation

See page 3).

Solutions Menu

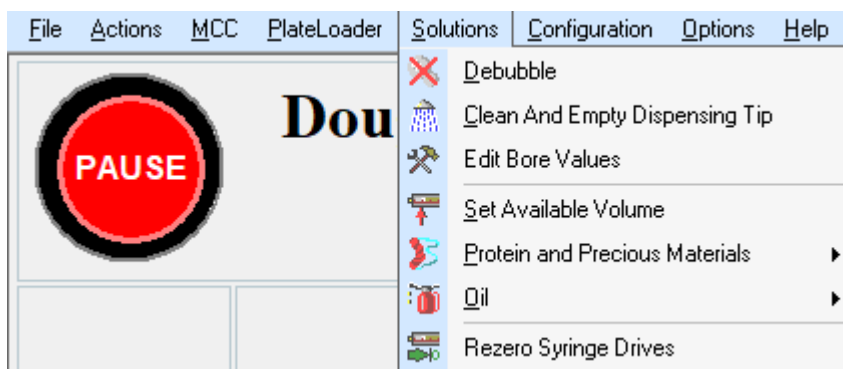

Debubble

Run the Debubble wizard to remove air from the tubing above the top valves.

Clean and Empty Dispensing Tip

See flush dispensing tip.

Edit Bore Values

Specify attributes for each dispensing bore. Typically this should not be used / edited.

Set Available Volume

Specify / Override volume of protein in the microtip. E.g. from 1.0 μ L to 12.0 μ L

Protein and Precious materials

Load and recover protein from the microtip.

Oil

Load and empty oil from the 1mL Rainin disposable tip.

Rezero Syringe Drives

Force a rezero of the Syringe Drives if it is believed that they are out of position or have been obstructed during use.

Configuration Menu

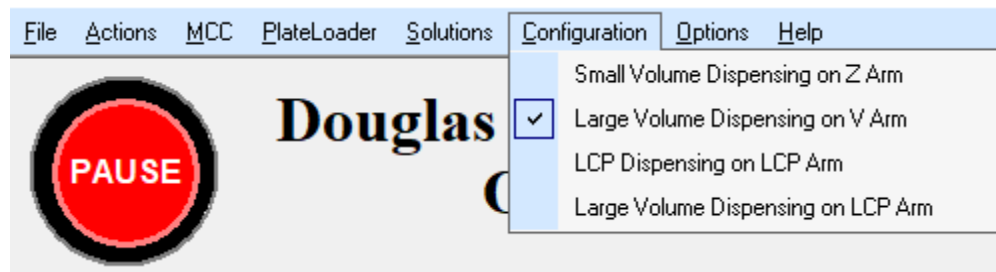

Small Volume Dispensing on Z Arm

Always on for Oryx Nano. Optional for Oryx4 if 4 channel small volume dispensing desired. Not used for Oryx8.

Large Volume Dispensing on V Arm

Default for Oryx4 and Oryx8. Large volume dispensing for Oryx4 and Oryx8 systems without LCP dispensing arm.

LCP Dispensing on LCP Arm

LCP Dispensing mode for Oryx4 and Oryx8 systems with the LCP dispensing arm. The software will automatically switch between 'LCP Dispensing' and 'Large Volume Dispensing on LCP Arm' modes depending on the requirement of the experiment.

Large Volume Dispensing on LCP Arm

Large Volume Dispensing on LCP Arm mode for Oryx4 and Oryx8 systems with the LCP dispensing arm. The software will automatically switch between 'LCP Dispensing' and 'Large Volume Dispensing on LCP Arm' modes depending on the requirement of the experiment.

Options Menu

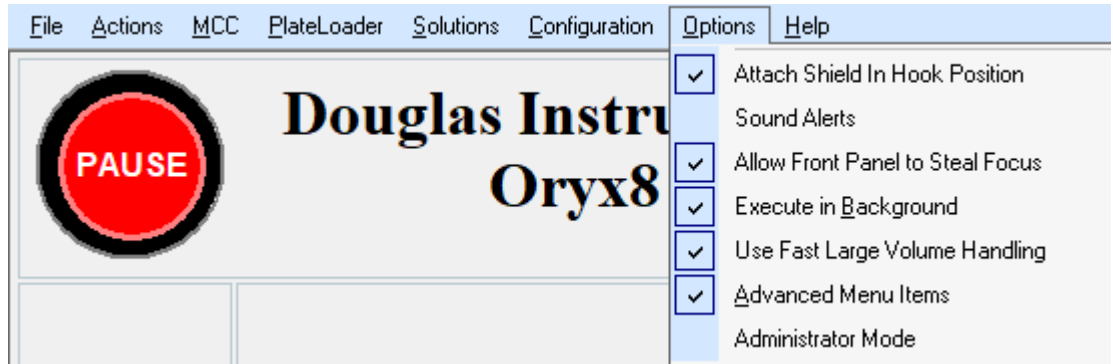

Attach Shield In Hook Position

On/Off. If on, the software will ask for the evaporation shield to be attached when the plateloader is in-line with the evaporation shield rail. This means the shield can be attached and pushed back to engage with the evaporation shield rail. Recommended = On

Sound Alerts

On/Off. If on, a .wav file will play to prompt a user when action is required or to prompt a user when the experiment is complete. Wav files are stored in C:\Program Files)\Douglas Instruments\Global Data\Sounds\Wav\ Default = Off

Allow Front Panel to Steal Focus

On/Off - Allows Front Panel to 'jump' to the front when called – overrides default Windows behavior of flashing the taskbar to get attention. Default = On

Execute in Background

Allows Front Panel to execute in the background while using other applications. Default = On

Use Fast Large Volume Handling

Enable faster technique for dispensing viscous precipitants for XStep reservoir dispensing Oryx8 only. Default = On

Advanced Menu Items

On/Off - Enables Menu Items for advanced users. Default = On

Administrator Mode

On/Off - Enables Advanced and diagnostic menus for Administrator use only. These menu items are not described in this manual and are generally only used by installers to set up and calibrate the system. Default = Off

Help Menu

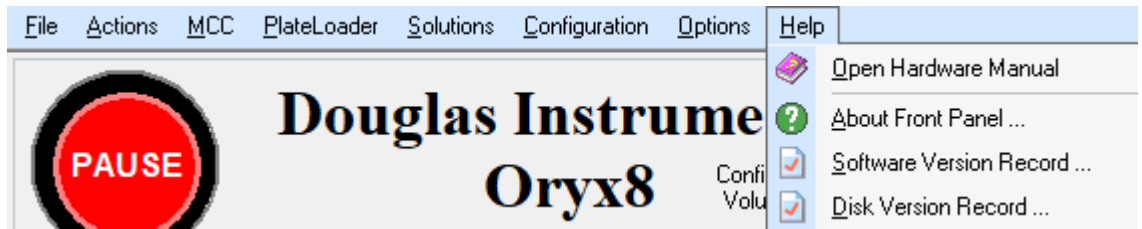

Open Hardware Manual

Open PDF version of the hardware manual.

About Front Panel

Displays Front Panel version information and Douglas Instruments contact information.

Software Version Record

Displays software version information.

Disk Version Record

Displays disk version information.

USE AND MAINTENANCE OF THE HARDWARE

Installing Microtips

Simply screw the colored end-fittings into the ports on the bottom of the lower valves, following the color-coding. The 2-bore Microtips are generally used for screening experiments, while the 7-bore Microtips are generally for optimization experiments.

Take a little trouble when installing Microtips. You will find that each tube has two “natural” positions (the tube runs back and then to the side, or, alternatively, to the side and then back). One of these natural positions allows the tube to clear the Plate Loader, whereas the other position causes the tube to collide with the Plate Loader. Choose the former.

Refilling 100 μ l Gas-Tight Syringes with Water

The 100 μ l syringes contain only degassed pure water. This means that there is no need to flush them when the stock solutions are changed. Degassing is very helpful in reducing bubbles.

When a motorized syringe is almost empty, the software will detect that it is necessary to refill the syringe with water. Follow instructions, including turning the upper valve to the refill position (\perp) as indicated.

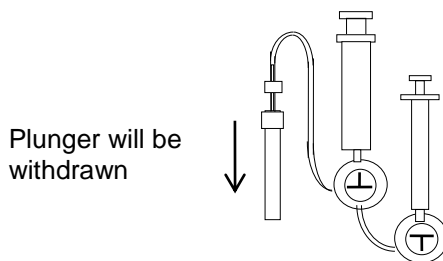

The refill valve position (\perp) is also used for rezeroing motors and debubbling.

Debubbling

It is essential that all tubing on channels 1–3 (1-7 on Oryx8) is completely filled with water, and that there are no air bubbles. Any air bubbles will cause significant inaccuracy in dispensing. The motorized syringes contain only degassed pure water. (If you do not use degassed water you may have to debubble up to twice a day.)

To debubble, Open Front Panel and select **Actions > Debubble**. Follow on screen instructions.

Flushing Tubing between Valves

It will occasionally be necessary to remove bubbles or to flush debris out of the short length of tubing between the upper and lower valves. Turn the upper valve to the flush position (\perp) and the lower valve to the fill position (\perp). Flush water from the ground glass syringe to the disposable syringe. This prevents debris from being flushed out of the microtip, which could cause blockages.

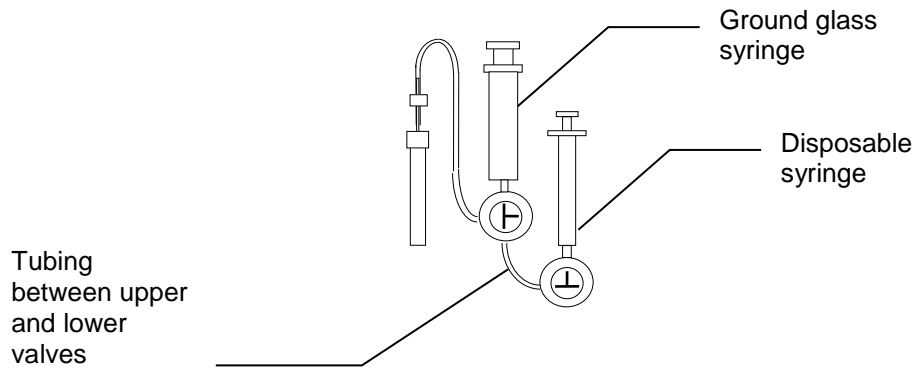

Filling Microtip with Solution

Software will tell you when to fill the Microtip with stock solution or water. Follow instructions, including turning the lower valve to the flush position (\perp).

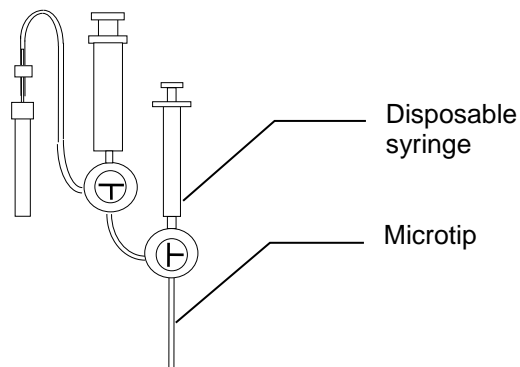

Dispensing Experiments

Follow instructions and turn all valves to the dispense position (\top) as shown:

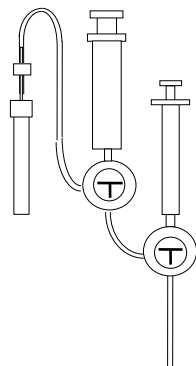

Attaching the Evaporation shield for Vapor Diffusion Experiments

1. Move slider next to plate and undo the clamp knobs to create a gap for the shield.

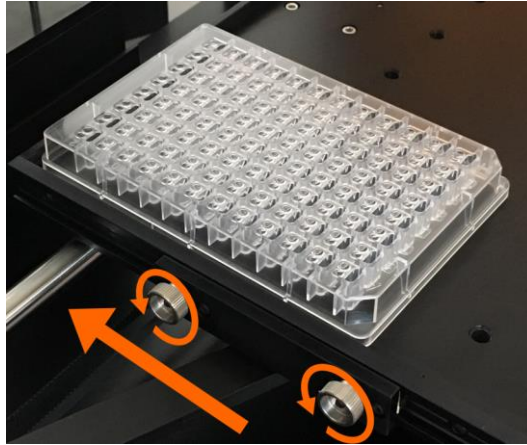

2. Place the shield onto the plate such that the large slot is over the middle of the plate and the groove on the side of the shield locating on the screws of the slider.

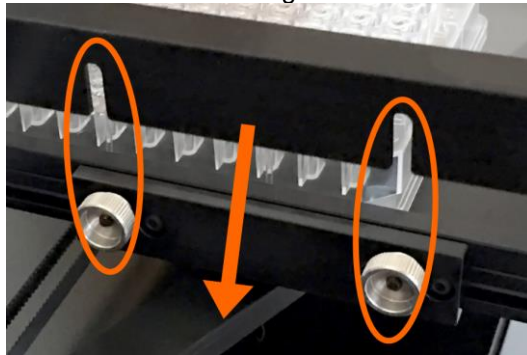

3. Put light pressure on the shield above the middle plate with one hand and tighten the knobs with the other.



4. Now leave the shield with the large slot over the middle of the plate and the machine will find it in the next step.

Flushing Microtip after Use

The Microtip should be thoroughly flushed after each session. Place a 1ml syringe containing distilled water in each valve in the lower row, turn the valve, and press in the plunger firmly. Repeat this three times. Finish by passing air through the Microtip and disconnecting. Store it coiled up and flat to avoid bending of the tip.



Always wear protective goggles when handling caustic materials

Protein Coatings of Microtip

Certain proteins may have a tendency to coat the inside of a microtip. This may cause the air bubble (that is used to separate the protein sample from the water in the microtip) to become stuck or to break up. To clean tips that are coated with protein we recommend to run the 'tip cleaning script' with a 2% solution of Hellmanex III (alkaline cleaning concentrate). This can be obtained from VWR or other laboratory suppliers. Use a 2% solution in water, then flush with water or a buffer. If this procedure does not work, run the 'tip cleaning script' with 1% Alconox Tergazyme (anionic detergent with protease enzyme) before running the 'tip cleaning script' again with Hellmanex III to remove the enzyme, then flush with water or a buffer.

Blockages

Keep syringes in all valves when not in use to avoid the ingress of dust. Never allow precipitant to come into contact with tubing that has previously contained protein unless it has been cleaned using alkali or acid – see above. Filter all solutions using a 0.45 μm filter or equivalent, and refilter any solutions that become cloudy or contain debris.

Unblocking Microtips

1. First try forcing the debris out of the tip with high pressure. This method is only possible when the Microtip is full of liquid. Fill a 100 μl gas-tight syringe with water. Attach a pointed 0.7 mm needle to it (this is the type of needle that spare syringes come with). Push this into the blocked bore of the Microtip at the End-Fitting. Press in the plunger of the syringe. Up to 100 atmospheres can be generated by this method.
2. If the above method does not work, try soaking the tip in 1M NaOH.

If this does not work we recommend that the tip is replaced with a new tip

Chemical Inertness

All surfaces that come into contact with solutions are chemically inert fluorocarbon polymers including FEP and PTFE. Only water comes into contact with the stainless steel needles of the gas-tight syringes.

Tubing Connections

The needles of the gas-tight syringes are connected to the FEP tubing by enlarging the bore at the end of the tubing and pressing onto the needle. If any syringes need to be replaced retain the special needles.

All other connections are made using gripper fittings. These are fitted as follows:

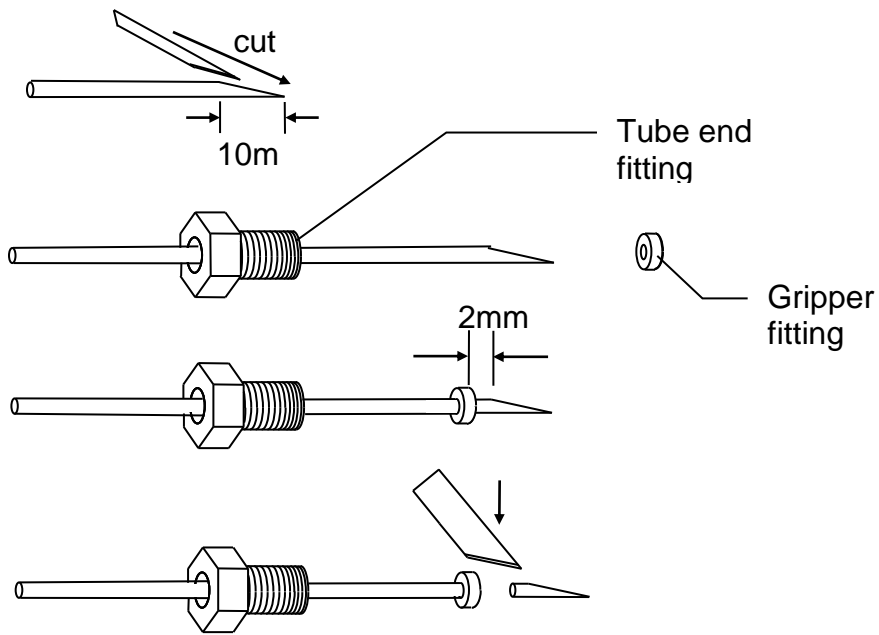

1. Taper the tubing with a scalpel by cutting it at an acute angle.
2. Pass the end through the tube end fitting and feed into the stainless steel side of the gripper fitting.
3. Grip the end of the tube with a pair of pliers and pull the tube through the gripper fitting beyond the tapered portion of the tube onto its full diameter, and rotate twice to grip the tube.
4. Pull the tube end fitting down to meet the gripper.
5. Trim the tube flush to the Teflon face of the gripper with a scalpel.

Lubrication of Syringe Drivers and Plate Loader.

Lubrication of Shafts

No lubrication will be required in the first year. Thereafter, inspect the shafts of the Plate Loader and the Syringe Drivers once a year. If they appear to be dry, lubricate them with one or two drops of hypoid gear oil - SAE 80W-90 or EP 80W-90 or similar. (This oil is used in e.g. car differential gears.) This will contribute to the smooth running of moving parts, and protect from air-borne corrosive materials such as are found in laboratories. (All parts are stainless steel or anodized aluminum, which will not generally corrode in the presence of moisture alone.)

Lead-screws

Lead-screws must not be lubricated with oil, as this may clog up the motors. Lead-screws are sparingly lubricated by Douglas Instruments with special compound for lubricating plastic. Please contact Douglas Instruments if you feel that your lead-screws need to be lubricated or if they become corroded.

Ball screws - used on syringe drives (USDs)

Ball screws must not be lubricated with oil. Ball-screws are sparingly lubricated by Douglas Instruments with Klüber Microlube GBU Y131. Please contact Douglas Instruments if you feel that your Ball screws need to be lubricated or if they become corroded.

Spillages

If large amounts of liquids are spilt on any of the electric motors, the system should be turned off. Salt, acid or alkali will cause corrosion of motors and stainless parts, and must be washed off with water. Allow the system to dry out before reusing. The motors and their connections are electrically safe since they run at 12 V.

XYZV Plate Loader

Adjustment of XYZV Plate Loader

The XYZV Plate Loader is adjusted so that it accurately moves to the center of wells on plates. Douglas Instruments performs this adjustment before shipping. If the Plate Loader is subjected to shock or if screws are slackened, it may need to be readjusted. The adjustment can be made in either hardware or software.

If you believe that the Plate Loader is in need of adjustment, please contact Douglas Instruments. Please do not attempt to make adjustments without consulting the company, since there are hidden complications in this procedure.

It is possible, however, to adjust the alignment of an individual microtip using Front Panel, providing the misalignment is less than about 2 mm.

HARDWARE CONFIGURATION AND CONTROL

Using Different Syringes with the System

Changing syringes is not normally recommended because the screening and optimization software will both have to be changed. In special cases it may be worth considering. We recommend that you consult Douglas Instruments before embarking on such a project.

Changing Plates

For a complete list of plates that can be used, consult the PLATES.DAT file in the directory *Global Data*. If the plate that you wish to use is not listed, then see the next section on adding new plate definitions.

WASP and WASPRUN

*.XPT files for WASP directly specify the plates to be used on the Plate Loader table. In order to use different plate types, the appropriate PLATE statement in the *.XPT file must be altered. This is simply a matter of using a text editor to modify the existing file.

The PLATE declaration statements are always near the top of the *.XPT file, and refer to plates by type name - e.g. Nunc HLA refers to a standard 6x12 Nunc HLA tissue culture plate. For a complete list of plates that can be used, consult the PLATES.DAT file in the directory *Global Data*. If the plate that you wish to use is not listed, then see the next section on adding new plate definitions.

XSTEP – Changing Plates

Plates can easily be changed in XSTEP simply by selecting *Dispensing Parameters*, then *Crystallization Plate*.

Hardware Configuration Files

The hardware is defined by HARDWARE.FTH. HARDWARE.FTH is found in the MCC folder, and it must be downloaded to the MCC. See the instructions for installing software.

Obviously, it is essential that the specifications match the hardware, and that these two files match each other. Please do not make any changes to either of these files. In exceptional circumstances Douglas Instruments may instruct you to make certain changes.

HARDWARE.FTH

The typical contents of HARDWARE.FTH are as follows:

```
string serialNumber "MCC454-136-239A"  
string hardwareDate "25/11/2008"  
string LastChangedDate "2015-01-20" (* RSB: Added LCP *)  
string userName "CSIRO, Australia"
```

Oryx4 DB7.0

.(Hardware settings for) userName count type cr

```
( Syringe drives, format : int:sno float:backlash [in mm] USDx.x )  
( USD1.0 = Leadscrew syringe drive - 314.96 half steps/mm )  
( USD2.0 = Ballscrew syringe drive, no limit switch - 200.00 half steps/mm )  
( USD2.1 = Ballscrew syringe drive, with limit switch - 200.00 half steps/mm )
```

```
1 0.0258 USD2.1  
2 0.0032 USD2.1  
3 0.0140 USD2.1  
4 0.0400 USD2.1 ForLargeVolume  
4 0.0400 LCP2.1 ForLCP
```

```
( PlateLoader format : x y z v pitch list XYZV5.x )  
( V5.7 =>Lz=60.5, Lv=50.5, NOx=0.0, NOy=0.0 )  
101.0 151.0 SetShieldHook
```

```
-13.1548 13.1658 39.5610 39.5913 XYZV5.7
```

Specifications

An up to date list of specifications for all Douglas Instruments' products can be found at

<http://douglas.co.uk/specs.htm>

Creating or editing plate definitions

- The plates definitions file is located in C:\Program Files\Douglas Instruments\Global Data\Plates(Oryx).dat
- The file contains all plate definitions. The most recent plate definitions are at the bottom of the file.
- Please see an example of a plate definition below with annotation and diagram.
- Plate Editor should be used to edit definitions (Programs > Douglas Instruments > Tools > Plate Editor)
- To create a definition, select a similar plate and click derive new. Save under new name to **plates(user).dat**.
- New plate names must not contain spaces hyphens and some other non-alphanumerical character. Use underscores (_) instead. Names should be under 16 characters long.
- Plate definitions added to plates(user).dat will not be deleted by reinstalling software, therefore customizations will remain. Plate definitions in the master file (plates(oryx).dat) will be over written by installing new software.

Annotated plate definition entry

Plate SwissCI_2Drop Source – Plate name as appears during experiment

TAGLIST LCP_Source – Identifier for plate definition to be included for certain experiment types (e.g. LCP experiments)

COLS 8 – Number of columns normally labelled A-H on 96 well plate

ROWS 12 – Number of rows normally labelled 1-12 on 96 well plate

COLLABEL A – Column labelling type A indicates Alphabetical

ROWLABEL 12 – Row labelling type A indicates Numerical

XPITCH 9.000 – Pitch between unit cells in X direction (See diagram)

YPITCH 9.030 – Pitch between unit cells in Y direction (See diagram)

XOVERALL 85.30 – Total width of plate (See diagram)

YOVERALL 127.50 – Total length of plate (See diagram)

HEIGHT 14.50 – Total height of plate

SHELFDEPTH 0.400 – Depth of shelf between reservoir and drop below total plate height. Set to 0.00 if in doubt. (See diagram)

Well Droplet

STYLE CCSHELF – style of drop well (See drop style diagram)

XOFFSET 9.70 – X Offset from edge of plate to centre of drop well for top left drop (usually A12)

YOFFSET 12.40 – Y Offset from edge of plate to centre of drop well for top left drop (usually A12)

DEPTH 1.40 – Depth of drop well centre below total plate height

WELLSIZE X 3.00 – Size of drop well in mm X axis

WELLSIZE Y 3.00 – Size of drop well in mm Y axis

RIMHEIGHT 0.50 – Size of rim around drop well mm Y axis. If drop and rim overlap reservoir, area of reservoir overlapped is ignored by robot.

RIMWIDTH 0.30– Size of rim around drop well mm X axis. If drop and rim overlap reservoir, area of reservoir overlapped is ignored by robot.

RIMCENTERX 0.00– Allows the position of the well to be moved for aesthetic reasons only (corrections to diagram of plate)

RIMCENTERY 0.00– Allows the position of the well to be moved for aesthetic reasons only (corrections to diagram of plate)

VOLUME 5.00 – max recommended volume of well

Well Reservoir

STYLE SQUARE

XOFFSET 11.20– X Offset from edge of plate to centre of well for most top left well (usually A12)

YOFFSET 16.50– Y Offset from edge of plate to centre of well for most top left well (usually A12)

DEPTH 9.50– Depth of reservoir well centre below total plate height

WELLSIZEX 7.00– Size of reservoir well in mm X axis

WELLSIZEY 7.00– Size of reservoir well in mm Y axis

RIMHEIGHT 0.10– Size of rim around drop well mm Y axis.

RIMWIDTH 0.10– Size of rim around drop well mm X axis.

RIMCENTERX 0.15– Allows the position of the well to be moved for aesthetic reasons only (corrections to diagram of plate)

RIMCENTERY -2.00– Allows the position of the well to be moved for aesthetic reasons only (corrections to diagram of plate)

VOLUME 80.00– max recommended volume of well

Drop style diagram

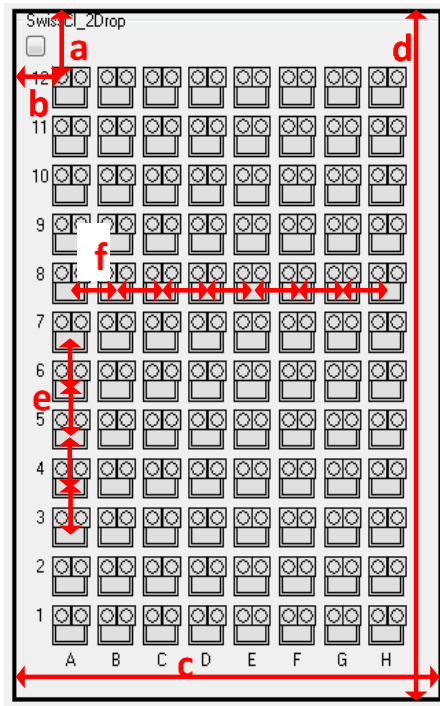

- a. YOFFSET droplet
- b. XOFFSET droplet
- c. XOVERALL
- d. YOVERALL
- e. YPITCH
- f. XPITCH
- g. RIMWIDTH
- h. RIMHEIGHT
- i. WELLSIZEY
- j. WELLSIZEX

diagram	description	style name
	Round	ROUND
	Shelf	CCSHELF
	Pillar	PILLAR
	Square	SQUARE

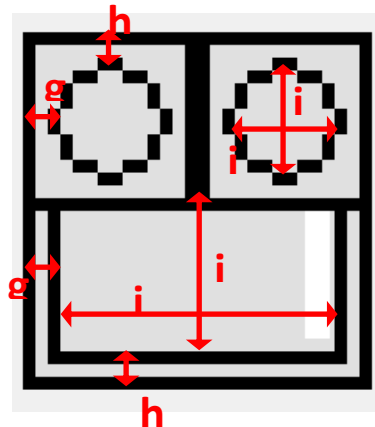

MCC BIOS SETTINGS

Motherboard: MSI A68HM-P33 V2

Produced by Raymond Baker on the 19/01/2017

Press Del after starting MCC to enter BIOS settings.

On Entering the BIOS Setup screen, Load Optimized Defaults

System Status

|Date | Month/Day/Year []
|time | Hour/Minute/Second []

Advanced

Intergrated Peripherals

| SATA Mode | IDE []

USB Configuration

| Legacy USB Support | Disabled []

H/W Monitor

| Smart CPU Fan Target | 70 °C []
CPU Min. Fan Speed (%) | 12.5% []
| PC Health Status | *Check System /CPU temps is close to 36/37 °C* []

]

Boot

Full Screen Logo Display |Disabled []

You can find the user manual on the MSI web site;

<https://www.msi.com/Motherboard/support/A68HM-P33-V2#down-manual>

HEALTH AND SAFETY ANALYSIS

Electrical Safety

The IEC 60320 mains supply inlet socket in the back of the MCC is actually part of the approved Power Supply Unit (PSU) that has its own internal fuse and ON/OFF power switch. There is no primary circuit outside this PSU apart from the detachable power supply cord set approved by BSI and using cable and IEC connector approved by many EU approvals bodies. This provides an approved separation between the hazardous mains voltage and all of the SELV secondary circuits of the machinery.

Mechanical Safety

The 5W stepper motors have insufficient power to cause injury to fingers trapped in pinch points on the Chassis and on the Plate Loader table. The microtip is made from a flexible polymer and presents no risk of piercing. Similarly, the oil-dispensing tip is not hazardous and the motorized syringe needles are blunted by removal of the sharp tips by special manufacture.

Chemical Safety

For the purpose for which this machine was designed there are no hazardous process chemicals. The instructions state that the user is responsible for the handling precautions of hazardous process materials should the user choose to use them for a purpose not foreseen by the manufacturer.

Emergency Stop

There is no need for an emergency stop on this small machine with no mechanical hazards. There is an ON/OFF switch (SELV) on the front of the MCC together with a red STOP button that stops all motion through software – See below.

Safety Features

- No electrical primary circuit except the approved mains supply cord set
- Overcurrent protection and dual redundant cooling fans within the PSU
- Restart needed after re-instatement of lost electrical power
- Low power stepper motors that present no mechanical risk
- Non-hazardous tips on dispensers and syringes
- Non-hazardous process materials
- User-friendly screens with instructions for use on screen
- Low noise level less than 70dB(A)

Risk Analysis

An essential pre-requisite to any machinery safety review is a risk analysis. The main risks, together with the descriptions of the methods adopted to eliminate the hazards presented by the machinery, are listed below:

1. Electrical.

Electrocution from contact (direct or indirect). The only hazardous voltage parts are the MCC Power Cord Set and Power Supply Unit, both approved parts. System has been inspected and tested.

2. Mechanical.

- Pinching, drawing-in, trapping and entanglement. Fingers caught in stepper drive mechanisms on XYZV Table and USD - 5Vdc Steeper Motors are so low powered (<5W) that they can be stopped with the finger easily without injury.
- Stabbing and puncture. Microtips, oil-dispensing tips and syringe needles - Microtips are made from flexible polymer material and syringe needles are specially blunted. Similarly, oil-dispensing tips are not hazardous.
- Mechanical overloads. Burn or fire from heat generated by stalled stepper motors - 5Vdc Steeper Motors are so low powered (<5W) that they can be stopped manually without any temperature rise. Overload protection not required for these low powered stepper motors.
- Fire. Burn or fire from high surface temperatures of the MCC enclosure - highest CPU core temperature in single fault conditions was 360°C – not capable of producing an external enclosure surface temperature > 700°C.
- Noise. Deafness through noise damage above 85dB(A) - The noise level is well below 70dB(A) and this fact is recorded in the Hardware Manual with no need to wear hearing protection.
- Hygiene. Process sample contaminated by microbiological organisms. The protein samples are not hazardous. Warning notice also in the Hardware Manual against use of hazardous materials.
- Unhealthy postures. The Oryx Protein Crystallization robots are located at ergonomic bench-top height with no likelihood of unhealthy postures.
- Unfriendly interactive software. Front Panel software on User PC - Screens are diagrammatical and easily understood.
- Failure of energy supply. Unexpected start up causing injury when power source re-instated - Machine will stop safely and the system must be re-initiated on the MCC and PC to re-start it after power is restored.
- Safety signs and signals. Lack of warnings of residual risks in the MCC, XYZV Table and USD - Warnings are provided at the front of the Hardware Manual.
- Manually fed/unloaded workpieces. Finger injuries from loading and unloading sample plates and bottle reservoirs - This is done outside hazard zones with the machine halted.
- Lack of instructions. Lack of information on operating and maintaining the Oryx machine as a whole – Hardware and Software Manuals covering installation, operation and maintenance are provided.

EU DECLARATION OF CONFORMITY

In accordance with of UK Decision No 768/2008/EC Annex III

1.

Product model / product:

Product Oryx Protein Crystallization machines
Model/type Oryx4 – V6.6, Oryx4 LCP – V6.6, Oryx Nano – V6.6, Oryx8 – V6.6, and Oryx8 LCP – V6.6
Batch/serial no. #MCC514 – XYZV180 to Current
2.

Manufacturer

Name Douglas Instruments Limited
Address Douglas House, Westfield Farm, East Garston, Hungerford RG17 7HD
3.

This declaration is issued under the sole responsibility of the manufacturer.
4.

Object of the declaration:

Product Oryx Protein Crystallization machines
5.

The object of the declaration described above is in conformity with the relevant Union harmonisation legislation:

2006/42/EC	The Machinery Directive
2014/30/EU	The Electromagnetic Compatibility Directive
2017/2102/EU	The Restriction of Hazardous Substances Directive
6.

References to the relevant harmonised standards used or references to the other technical specifications in relation to which conformity is declared:

Reference & Date	Title
BS EN 60204-1:2018	<i>Safety of machinery. Electrical equipment of machines. General requirements</i>
BS EN IEC 62368-1:2020+A11:2020	<i>Audio/video, information and communication technology equipment. Safety requirements</i>
IEC 60034-20-1:2004	<i>Rotating electrical machines. Control motors. Stepping motors</i>
BS EN 55032:2015	<i>Electromagnetic compatibility of multimedia equipment. Emission Requirements.</i>
BS EN 55035:2017+A11:2020	<i>Electromagnetic compatibility of multimedia equipment Immunity requirements</i>
BS EN 61000-3-2:2014	<i>Electromagnetic compatibility (EMC). Limits. Limits for harmonic current emissions (equipment input current ≤ 16 A per phase)</i>
BS EN 61000-3-3:2013	<i>Electromagnetic compatibility (EMC). Limits. Limitation of voltage changes, voltage fluctuations and flicker in public low-voltage supply systems, for equipment with rated current ≤ 16 A per phase and not subject to conditional connection</i>
7.

Additional information:

The Authorities Representative responsible for storing the technical documentation

Name: CE Marking Authority
Address: 3 Ferndale Grove, Newtownabbey, Co. Antrim BT36 5AP Northern Ireland
Technical File No: CEMA-21-070660EU
8.

Signed for and on behalf of: Douglas Instruments Limited
Place of issue: Douglas House, Westfield Farm, East Garston, Hungerford RG17 7HD
Date of issue: 09/07/2021
Name: Patrick Shaw Stewart
Function: Director
Signature: 

UK DECLARATION OF CONFORMITY

In accordance with of UK Decision No 768/2008/EC Annex III

9. *Product model / product:*
- Product Oryx Protein Crystallization machines
Model/type Oryx4 – V6.6, Oryx4 LCP – V6.6, Oryx Nano – V6.6, Oryx8 – V6.6, and Oryx8 LCP – V6.6
Batch/serial no. #MCC514 – XYZV180 to Current
10. *Manufacturer*
- Name Douglas Instruments Limited
Address Douglas House, Westfield Farm, East Garston, Hungerford RG17 7HD
11. *This declaration is issued under the sole responsibility of the manufacturer.*
12. *Object of the declaration:*
- Product Oryx Protein Crystallization machines
13. *The object of the declaration described above is in conformity with the relevant Union harmonisation legislation:*
- SI 2008 No 1597 Supply of Machinery (Safety) Regulations
SI 2016 No. 1091 Electromagnetic Compatibility Regulations 2016
SI 2012 No 3032 The Restriction of Hazardous Substances Regulations
14. *References to the relevant harmonised standards used or references to the other technical specifications in relation to which conformity is declared:*
- | Reference & Date | Title |
|---------------------------------|-----------------------------------------------------------------------------------------------------------------------------------------------------------------------------------------------------------------------------------------------------|
| BS EN 60204-1:2018 | Safety of machinery. Electrical equipment of machines. General requirements |
| BS EN IEC 62368-1:2020+A11:2020 | Audio/video, information and communication technology equipment. Safety requirements |
| IEC 60034-20-1:2004 | Rotating electrical machines. Control motors. Stepping motors |
| BS EN 55032:2015 | Electromagnetic compatibility of multimedia equipment. Emission Requirements. |
| BS EN 55035:2017+A11:2020 | Electromagnetic compatibility of multimedia equipment Immunity requirements |
| BS EN 61000-3-2:2014 | Electromagnetic compatibility (EMC). Limits. Limits for harmonic current emissions (equipment input current ≤ 16 A per phase) |
| BS EN 61000-3-3:2013 | Electromagnetic compatibility (EMC). Limits. Limitation of voltage changes, voltage fluctuations and flicker in public low-voltage supply systems, for equipment with rated current ≤ 16 A per phase and not subject to conditional connection |
15. *Additional information:*
- The Authorities Representative responsible for storing the technical documentation*
- Name: Douglas Instruments Limited
Address: Douglas House, Westfield Farm, East Garston, Hungerford RG17 7HD
Technical File No: DI Oryx TF 3.1
16. Signed for and on behalf of: Douglas Instruments Limited
Place of issue: Douglas House, Westfield Farm, East Garston, Hungerford RG17 7HD
Date of issue: 09/07/2021
Name: Patrick Shaw Stewart
Function: Director
Signature: 

EXPERIMENT CARDS FOR ORYX

Oryx Quick Start Card

1. Design experiment:

- a. Open WaspRun or XStep.
- b. Choose experiment type and specify experiment variables. Drop volumes, Plate type, where to dispense to etc. *See **experiment cards or instructions in WaspRun for specific details.***
- c. Click “dispense” to begin experiment.

2. Prepare robot for experiment:

- a. After clicking dispense FrontPanel.exe will open.
- b. Front Panel will guide you through the preparation for the experiment with step by step instructions. It is important to follow the instructions.
- c. Place plate(s) and rinse jars with de-ionised water onto the plateloader table.
- d. Test and adjust the Microtip position. It should be centred to a drop well and just touching the plate when lowered. The system is contact dispensing and it is important that the tip touches the plate when dispensing.
- e. Attach the evaporation shield. Ensure the shield can slide freely over the plate.
- f. Follow on screen instructions to debubble and flush tubing.
- g. The robot will now ask for protein and other precious samples.

3. Dispensing the experiment:

- a. After the protein has loaded the robot will begin pipetting the experiment.
- b. The experiment can be paused by clicking the “Pause” button in the top left hand corner of Front Panel. The Pause menu will now appear. If necessary the Microtip position can be re-adjusted. The experiment can also be stopped then resumed.

Oryx Maintenance Card

Daily maintenance

- Fill the 5 mL ground glass syringes with degassed water
- Ensure the system is fully debubbled. The debubble wizard automatically appears before the first experiment of the day, or can be called manually in Front Panel: Actions > debubble.
- Ensure that rinse jars 1-3 are cleaned and filled with de-ionised water. The waste jar should be empty and clean.
- Keep the plateloader clean. Wipe the table with water or alcohol if necessary.
- Ensure the Microtip is installed and adjusted. See www.douglas.co.uk/GoodDisp.htm

Weekly maintenance

- Run the tip cleaning wizard if necessary. WaspRun > tools > Tip Cleaning. Use Hellmanex III 1% or NaOH 0.1 M. Thoroughly rinse tip with water or buffer afterwards.
- Change to a new Microtip if necessary.
- Apply a small amount of silicon vacuum grease to coat the outside of the Microtip.

Yearly maintenance

- Apply a small amount of Hypoid 80w/90 oil to the 10 and 12 mm stainless steel shafts. Do not apply oil on timing screws or belts.

Optimization Experiment Card

Experiment design

1. Open **XStep** by double clicking the desktop shortcut:
2. Create a new Project. (File -> New Project.)



- The spreadsheet design interface will open.
- On the left of the spreadsheet the first 6 ingredients are shown. The seventh ingredient is always water and is not shown.
- The user can choose to edit the drops or reservoir **(1)**
 - Drops. Concentration calculated after dilution with protein
 - Reservoir. Concentration of reservoir solution.
- The spreadsheet is normally viewed in **Concentration** mode. The user can also view well composition by: volume, percentage volume or number of motor steps. **(2)**

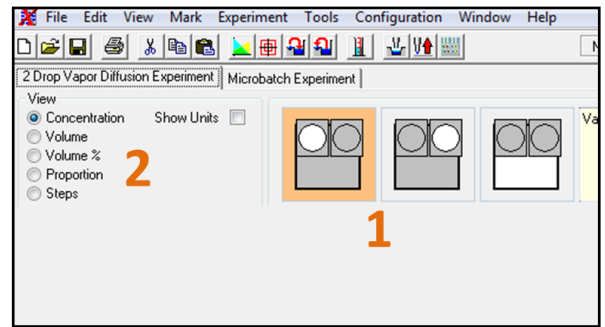

3. Specify experiment type. (Experiment -> Experiment type)
- There are 3 types of experiment:

- Microbatch under oil.**
Dispenses drops and covers with oil.
- Vapour diffusion.**
Dispenses both the equilibration reservoir and the drop.
- Stock Plate preparation.**
Dispenses just the reservoir or stock solution.

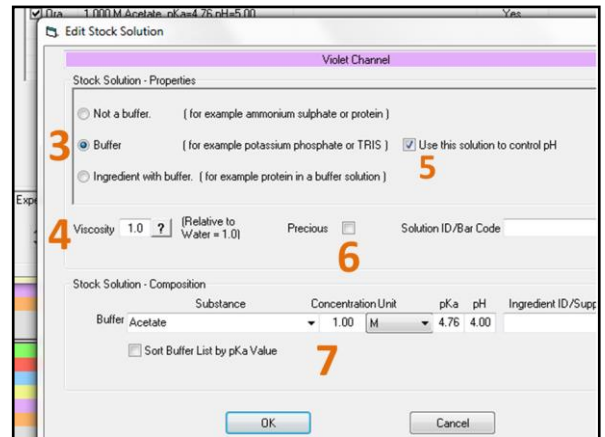

4. Choose Plate type. (Experiment -> Plate)
E.g. MRC Maxi, Douglas Vapour batch
5. Specify Ingredients for the experiment.
Experiment -> Stock solutions

- a. Clicking on ingredients allows them to be edited
- b. Specify ingredient type. Whether it is a buffer or not. **(3)**
- c. Viscosity. Set to 1.0 for non-viscous solutions. E.g. Set to 20.0 for 50% PEG 3K. **(4)**
- d. Use buffer to control pH (buffer type only.) Select to use buffer as pH controller

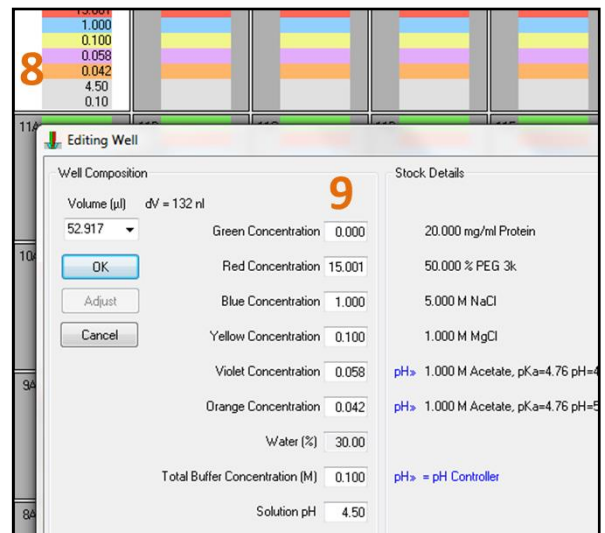

for drop or reservoir pH.
(5)

- e. Precious. If a solution is precious it is dispensed to just the drop and not the reservoir. (6)
- f. Ingredient name, concentration and pH. (7)

6. To create a multivariate **auto design** experiment:

- a. Select a well e.g. reservoir 12A. Right click and select edit. This opens the **Edit Well** window. (8)
- b. Specify the central condition for the optimization. E.g. the hit condition (9) when done click ok.
- c. Right click the well and select **auto design**.
- d. Specify the variation of each ingredient (10)
- e. Choose Box Benken or Central composite experiment designs. Or choose how many parameters to vary. (11)
- f. Click ok to generate the experiment. (12)

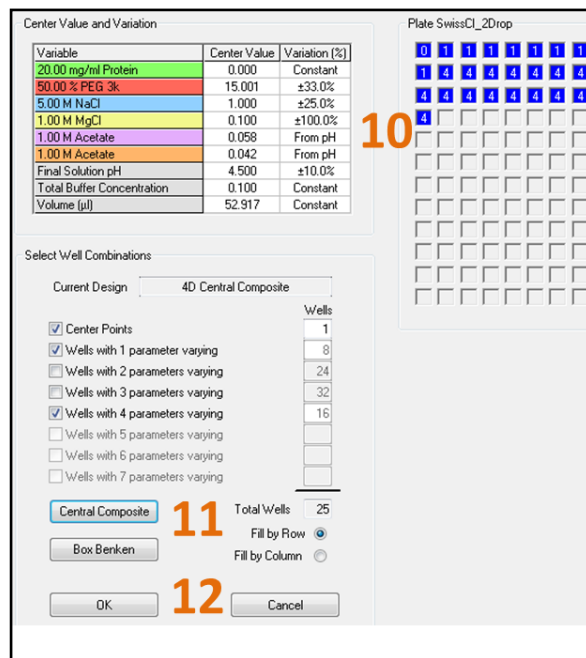

7. To design a **gradient** optimization experiment:

- a. Specify Maximum and minimum conditions for the gradient in opposite corners of a block of wells.
- b. Drag a grid over the block of wells (13)
- c. Click **Interpolate**. (Tools -> Interpolate)
- d. Specify whether the gradient ranges from **top left to bottom right**, or **bottom left to top right**. (14)

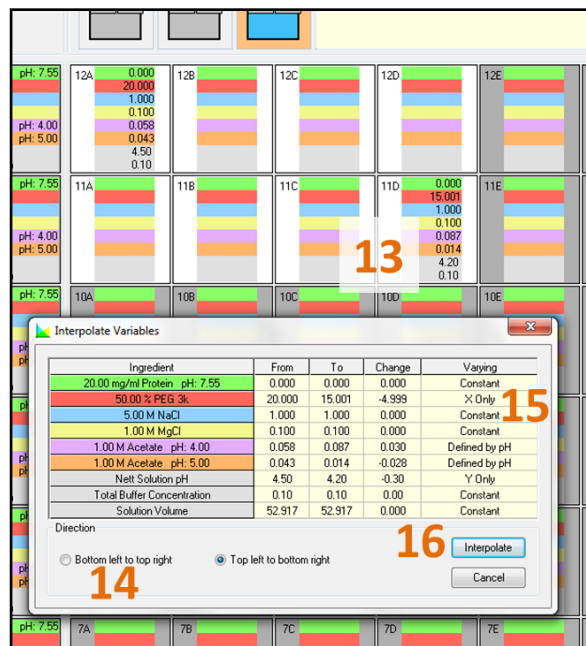

- e. Choose which ingredients to vary in which axis. (15)
- f. Click interplotate to generate gradient. (16)

8. Generate drops from reservoirs. If the experiment was designed by editing the reservoir then it is possible to automatically generate the corresponding protein drop for vapour diffusion experiments. Click **Generate drop solution from reservoirs (17)**. The user will then be asked to specify the drop volume and proportion of protein in the drop

9. It is also possible to **Generate reservoir solutions from drops (18)** if the experiment was designed in drop view.

10. Click the **dispense** button to begin the experiment: 

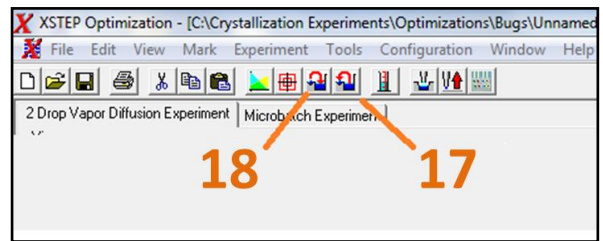

Good dispensing guide for the Oryx range of robots

1. Make sure that there are no air bubbles in the motorized syringes or in the tubes. If you see bubbles, run the Actions | Debubble routine in Front Panel as usual.
2. Check that the microtip can move freely, and that it falls back into position if it is lifted up. The tip should be “spring loaded”, or, to be more precise, gravity loaded. If it does not fall back, adjust the angle of the “guide loop” and the position where the guide loop grips the microtip tubing. Normally, the microtip should meet the arm at right angles (viewed from the front and from the side).

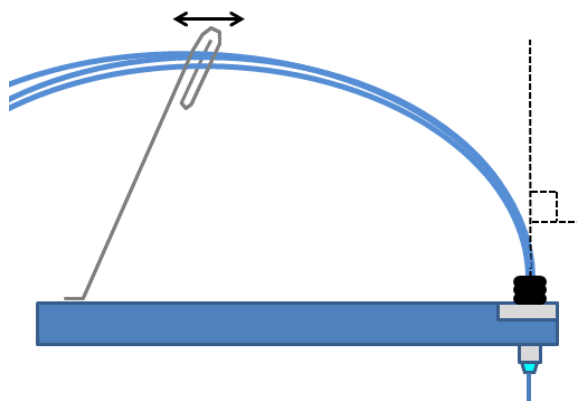

3. You can adjust the position where the tip is dispensing into the wells by pressing the Pause button during an experiment. Change the position with the arrow keys or the mouse on the diagram shown.
4. If you think there is a mistake in the definition of the plate, you can make corrections of up to around 1 mm by selecting PlateLoader | Calibrate plate in Front Panel.
5. If the tip is too high, some drops may be missing. If the tip is too low, the drops may be positioned irregularly. On the whole it is better for the tip to be too low than too high.
6. We recommend greasing the outside of the tip. If protein sticks, it can then be wiped off and fresh grease applied. Don't get grease in the end. (If you do get grease in the end of the tip, it will be cleared after one or two plates.) You can use petroleum jelly (Vaseline) or silicone grease.
7. Try to keep the tip vertical. If it is not vertical, part of the drop may stick to the tip. The tip can be straightened with the fingers. Note that it may move back slowly towards its original position.
8. Don't use UV-compatible (UVP) plates unless you are using detergents. Use polystyrene (PS) plates. UVP plates are more hydrophobic, and part of the drop may stick to the tip and be picked up. (This varies from protein to protein. There may be no problem with your protein.)
9. When you are dispensing plates with two drops, you may find that the first drop to be dispensed is smaller than the second. This indicates that part of the drop is sticking to the tip. This material ends up in the second drop. (If part of the second drop is subsequently picked up it will end up in the next reservoir, so the second drop will typically be the correct size.) Check points 5 to 8 above.
10. The tip is almost completely inert and can be cleaned with acids, bases, detergents etc. We recommend cleaning with Hellmanex II, which is a cleaning solution that can be obtained from VWR. (We have not tried it's successor Hellmanex III.) It is used as a 1% solution in water. We recommend sucking a little solution into the tip and flushing with buffer after use to remove the cleaning solution. We clean our tips roughly once a month, or when we see a problem.

Index of Manual

A		O	
Adjustment of Plate Loader	27	optimization	40
B		Optimization Experiment Card	38
Blockages	25	Oryx Maintenance Card	38
Bubbles, removing	22	Oryx Quick Start Card	37
C		P	
Chemical inertness.....	25	Performance of Plate Loader - testing	13
Cleaning microtip	25	Plate Loader	
Creating or editing plate definitions	30	testing performance	13
D		Plates	
Daily maintenance	38	changing.....	28
Debubbling.....	22	changing.....	28
Degassed water, use of	22	Prepare robot for experiment	37
Design experiment.....	37	Q	
Dispensing		Quick Start Experiment Card	37
Good dispensing guide for the Oryx range of robots		R	
.....	41	Recording the positions of motors	9
E		Refilling Motorized Syringes with water	22
Electrical connection.....	8	Rezeroing motorized syringes	10
F		Rezeroing Plate Loader.....	14
Filling Microtip with solution	23	S	
Flushing Microtip after use	25	Software installation	9
Flushing tubing between valves.....	23	Specifications	29
H		Spillages.....	27
HARDWARE.CFG	29, 30	Syringes	
HARDWARE.FTH.....	29	debubbling	22
I		filling with degassed water	10
Installing Microtips	22	mounting.....	10
Installing the Z and V arms.....	8	Syringes, changing	28
L		System Overview Diagram	7
Lay-out of the hardware	6	T	
LCP		Tesing performance of Plate Loader.....	13
Release LCP Syringe (LCP Dispensing Only)	16	Tubing connections	25
Logging motor positions to disk	9	U	
Lubrication	27	Unblocking Microtips	25
M		W	
MCC Motion Control Center	6	Weekly maintenance.....	38
Microtip		X	
collisions with Plate Loader	22	XStep	39
installing	22	Y	
protein coatings.....	25	Yearly maintenance.....	38
unblocking	25		